



*Thinking of you*  
**Electrolux**

# Tag der Küchen-Neuheiten

Referent: Beat Kommaier

Verkaufsleiter Zürich und Ostschweiz



# Der neue SL Profi Steam



*Thinking of you*  
**Electrolux**

Neu: SL Profi Steam mit externem Verdampfer (60cm/45cm/SMS)



# Der neue Profi Steam SL Klasse (60cm/45cm/SMS)



**VarioGuide** Display mit  
Symbol- und Text



Entnehmbarer  
Wassertank



Externe  
Dampferzeugung

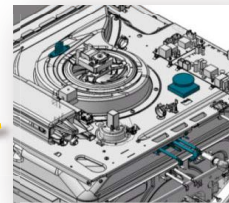

Feuchtigkeitssensor

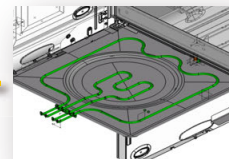

Abdampfungs-Phase  
(trockener Boden)



## Der neue Profi Steam SL Klasse ( 60cm/45cm/SMS)

- Neuer Dampfgenerator außerhalb des Garraums
- Feuchtigkeitssensor für perfektes Garraumklima – auch die Eigenfeuchte des Garguts wird mit berücksichtigt
- „Dampf nach Bedarf“ –  
Dynamische Dampferzeugung  
Dank Feuchtigkeitssensor
- Konstant hohe Qualität –  
Ergebnisse, die immer wieder überzeugen
- VarioGuide – Einstellungsempfehlung für  
220 Gerichte (Beheizungsart, Temperatur, Dauer, Feuchte)
- Weniger Wasser- und Energieverbrauch
- Größerer Wasserbehälter (950 ml) – entnehmbar für leichtes Befüllen und Entleeren

# Neu: Feuchtigkeitssensor und 220 Rezepte (inkl. SousVide)

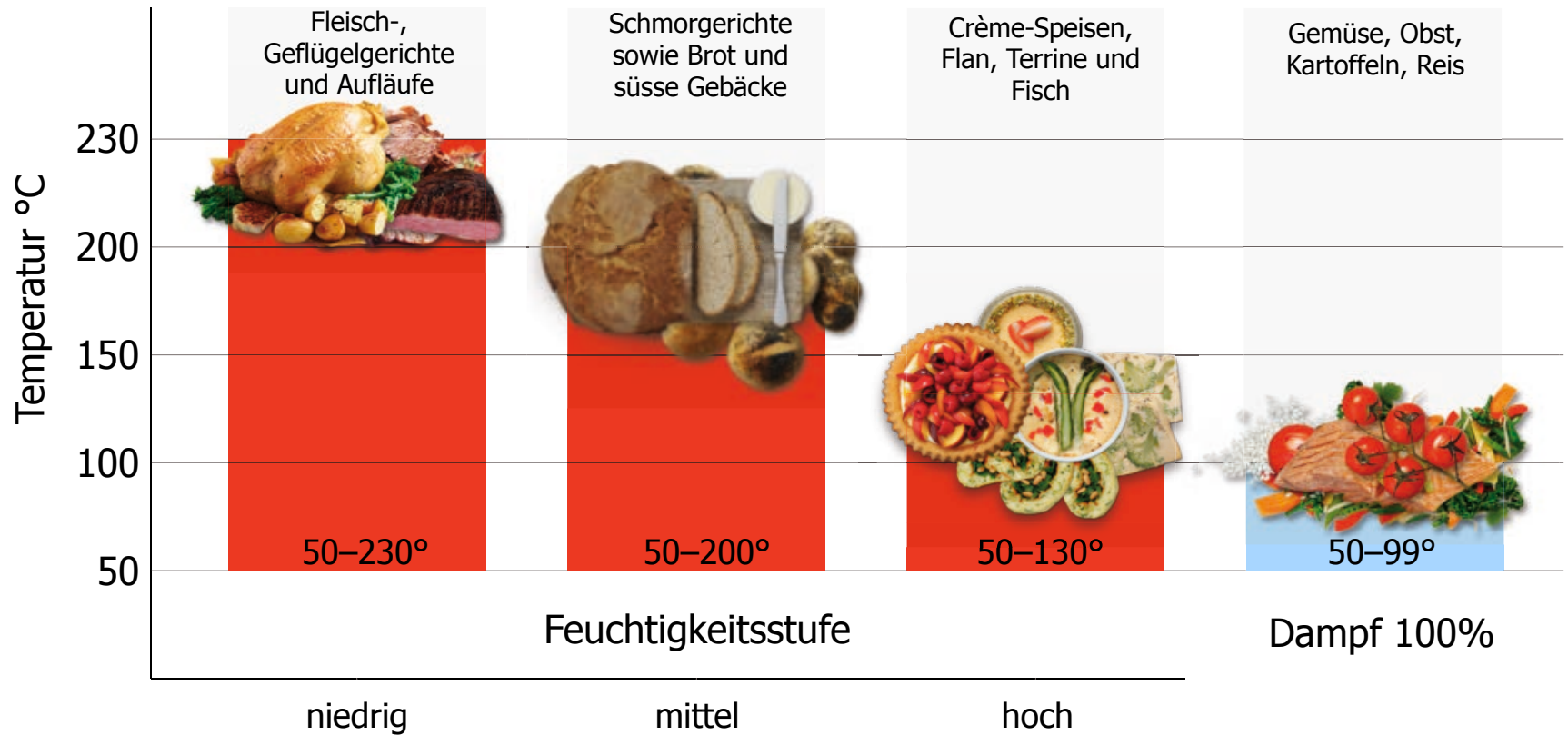

## «SousVide» Das exklusive System mit Profi VAC von Electrolux





# Neue 45er Compact Geräte



# Neu: Sortimentserganzung CompactLine 45 Pyrolyt



## Pyrolyt Einbaubackofen Heissluft/konventionell/Grill

### Besondere Merkmale

- ★ Display mit Symbol- und Klartextanzeige
- ★ 90 vorprogrammierte Rezepte
- ★ Pyrolytische Selbstreinigung
- ★ Speisethermometer mit Endzeitberechnung



### Bedienung/Ausstattung

- Touch-Bedienung
- Elektronische Backofenregelung 30–300°C
- Pyrolytisches Selbstreinigungssystem

### Programme/Funktionen

- 17 Beheizungsarten
- Niedertemperaturautomatik
- Speicher fur 20 eigene Programme
- Pyrolyse-Empfehlung

# Flächenkochen Profi Line



*Thinking of you*  
**Electrolux**

# Sortimentserweiterung Profi Line

## 38er Induktions-Kochfeld GK38TSIDO

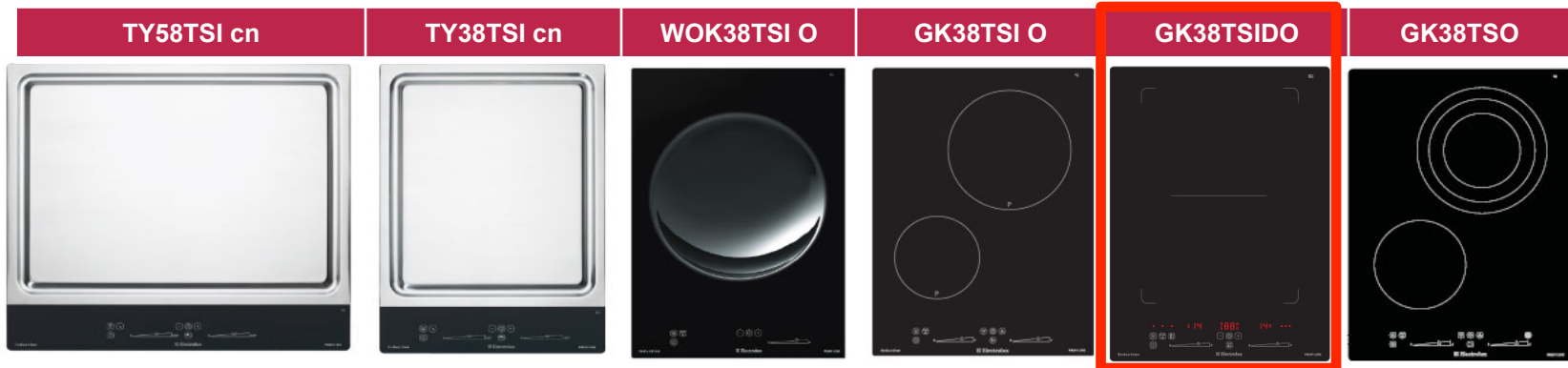

### GK38TSIDO

- Abmessungen: 380 x 510 x 55
- Rahmen: O-Version (ohne Rahmen)
- Spulen: 2 Oval-D-Spulen à 170 mm x 265
- Einbau: Flächenbündig oder aufliegend
- Nutzen: Für Bräter optimiert
- Positionierung: Erweiterung ProfiLine

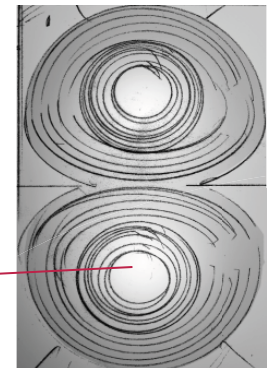
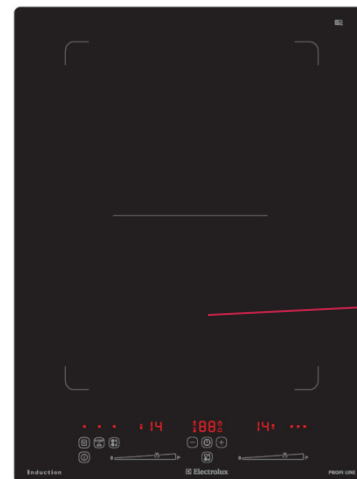

# Flächenkochen Design-Update

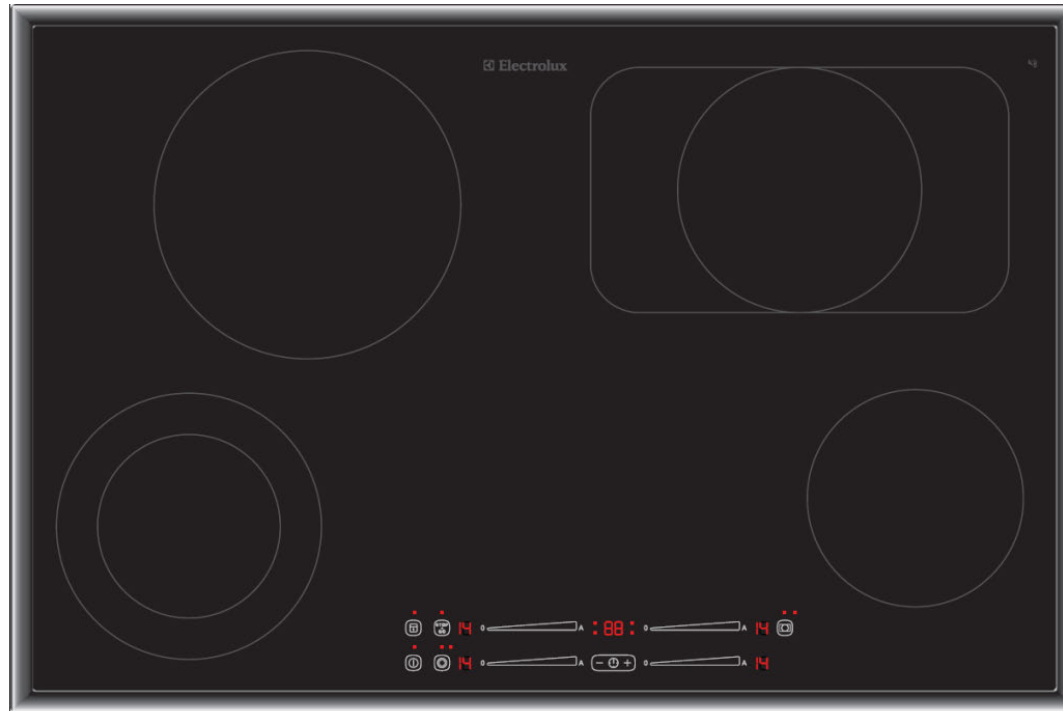

Nutzen: Erhöhung der Designwertigkeit durch dunklere Bedruckung der Kochzonen.

Bedienfeld-Bedruckung wird dagegen hell belassen, damit gute Ablesbarkeit garantiert ist.

# Dunstabzug



*Thinking of you*  
**Electrolux**

Neu: Flachschildunstabzug SL, tiefster Energieverbrauch der Schweiz A -66%



Neu: Flachschildunstabzug SL, tiefster Energieverbrauch der Schweiz A -66%

Umluft Flachschildunstabzug

Breite 55 / 60 / 90 cm

- Niedrigster jährlicher Energieverbrauch 17 kW/h (A -66%)
- Beste Geruchsreduzierung mit 2 reg. Long Life-Aktivkohlefilter à 1.5 kg
- Ergonomisches Filterkonzept alle Filter bequem von vorn zugänglich
- Touch Tastatur für hohen Bedienkomfort
- Hervorragende Dunst-Erfassung dank langem Glasauszug
- Eleganter, flacher Glasauszug, Höhe 1.7 cm





# Neu: Vollintegrierter Glasauszug für den unsichtbaren Einbau 55cm/60cm/90cm



## Neu: Umluft Deckendunstabzug



# Geschirrspüler



*Thinking of you*  
**Electrolux**

# Neu: Geschirrspüler Euronorm A+++



	Modell 2014	Modell 2015
GA60SLIS	A++	A+++
GA60GLIS	A++	A+++
GA60GLVS	A++	A+++

# Neu: Geschirrspüler Euronorm für jede Nischenhöhe

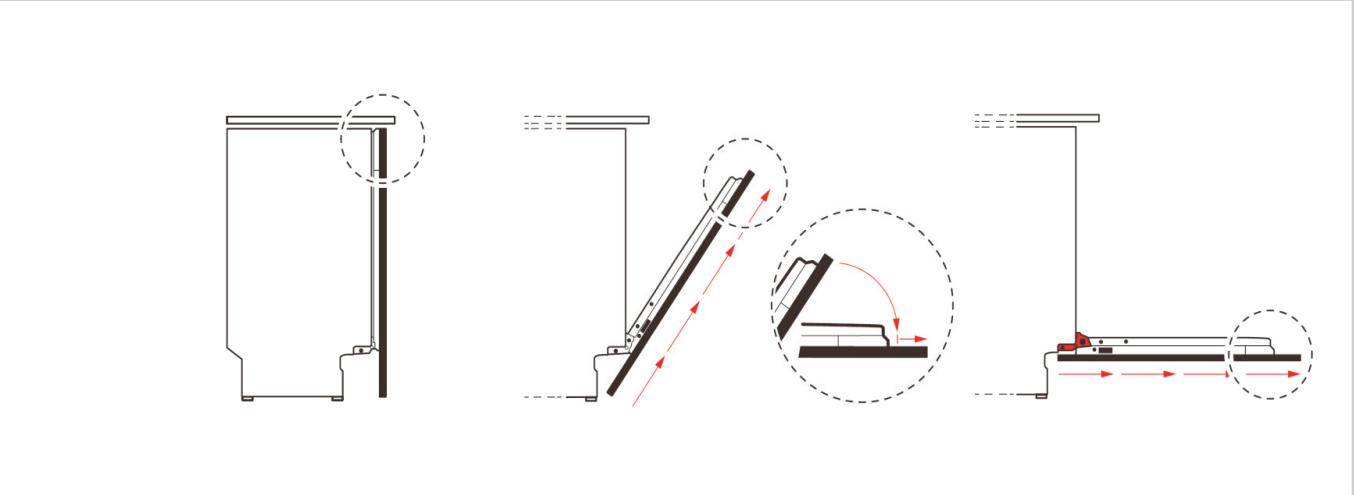

# Kühlen A+++ Frostfree



*Thinking of you*  
**Electrolux**

Neu: Frost Free Technik beim IK2550BN, nie mehr abtauen, A+++



Neues Lichtkonzept LED



Soft Cloosing

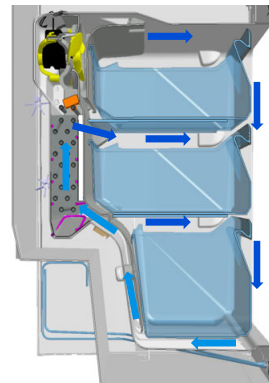

FrostFree Technik



# Besten Dank!

Neuheiten Flyer beim Electrolux Stand



*Thinking of you*  
**Electrolux**